

Part No. 042-0001

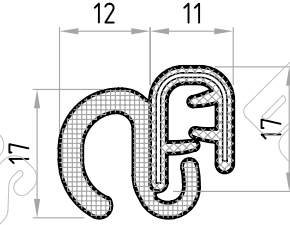

Part No. 042-0002

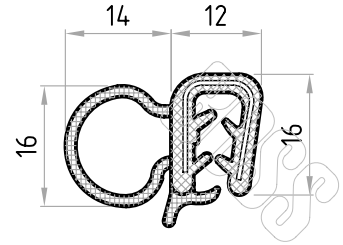

Part No. 042-0003

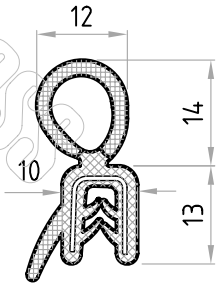

Part No. 042-0004

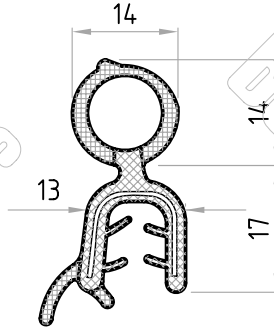

Part No. 042-0005

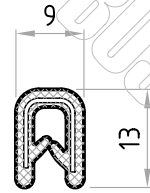

Part No. 042-0006

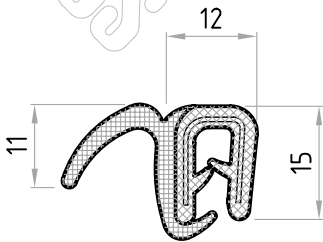

Part No. 042-0007

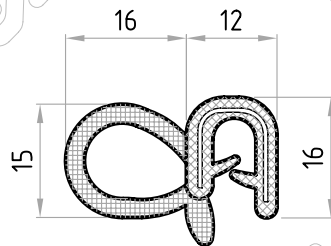

Part No. 042-0008

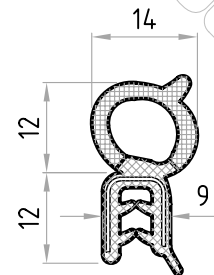

Part No. 042-0009

All supplied in 50 metre coils  
All dimension in millimetres

\* Profile drawings appearing in this section are indicative only. some profiles may be restricted to specific customers, patents and or other limitations.  
The material displayed on this page may not be reprinted or otherwise reproduced without the express written permission of Boss Polymer Technologies.

BOSS POLYMER TECHNOLOGIES PTY LTD  
Melbourne Australia  
PH: (613) 9561 2777  
FAX: (613) 9560 8777  
www.bosspolymer.com.au  
E-MAIL: sales@bosspolymer.com.au

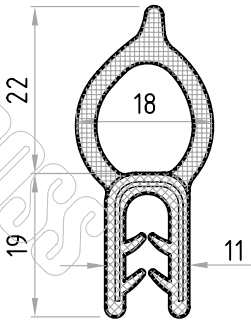

Part No. 042-0010

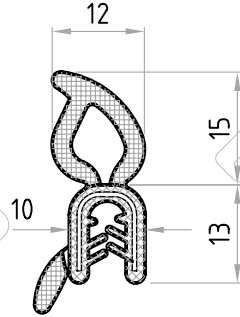

Part No. 042-0011

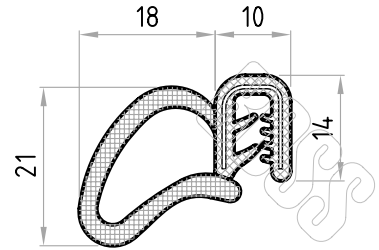

Part No. 042-0012

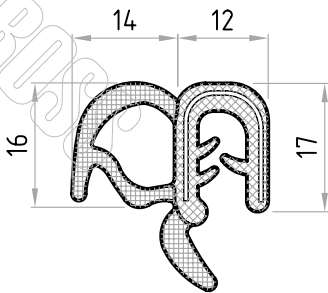

Part No. 042-0013

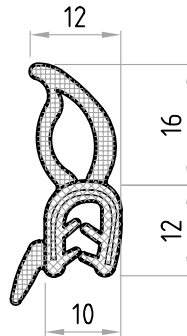

Part No. 042-0014

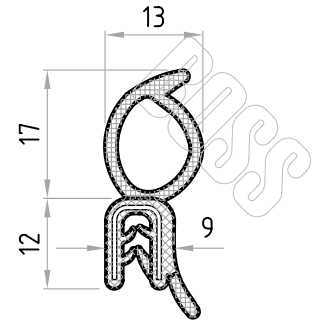

Part No. 042-0015

Equiv. to BS263376

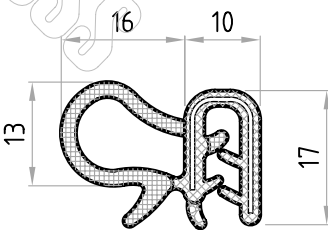

Part No. 042-0016

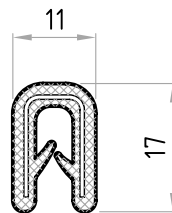

Part No. 042-0017

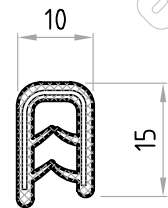

Part No. 042-0018

All supplied in 50 metre coils  
All dimension in millimetres

\* Profile drawings appearing in this section are indicative only. some profiles may be restricted to specific customers, patents and or other limitations.  
The material displayed on this page may not be reprinted or otherwise reproduced without the express written permission of Boss Polymer Technologies.

BOSS POLYMER TECHNOLOGIES PTY LTD  
Melbourne Australia  
PH: (613) 9561 2777  
FAX: (613) 9560 8777  
www.bosspolymer.com.au  
E-MAIL: sales@bosspolymer.com.au

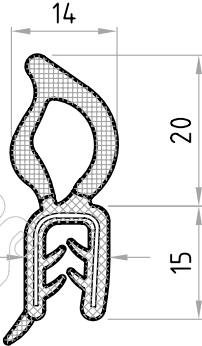

Part No. 042-0019

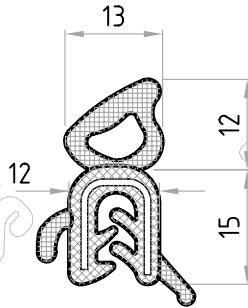

Part No. 042-0020#

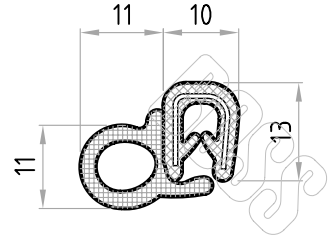

Part No. 042-0021

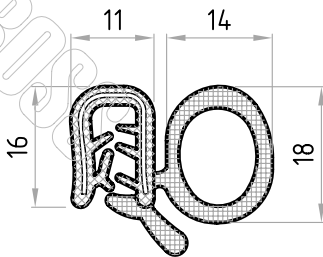

Part No. 042-0022#

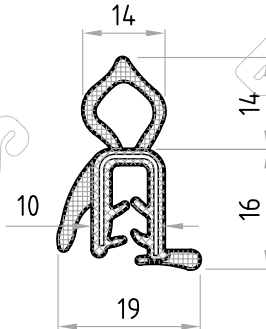

Part No. 042-0023#

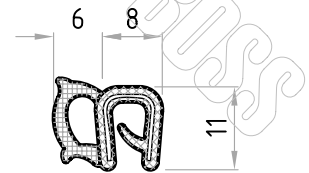

Part No. 042-0024

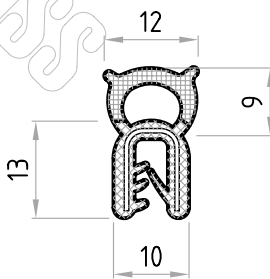

Part No. 042-0025

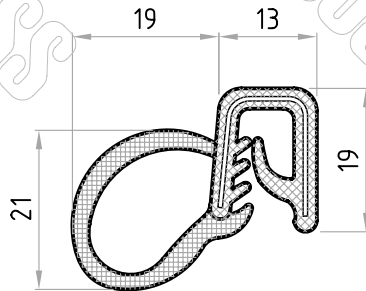

Part No. 042-0026

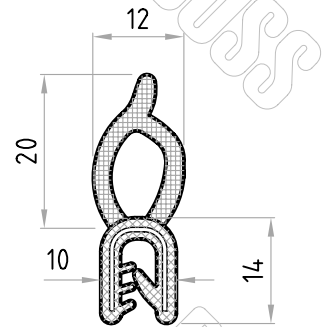

Part No. 042-0027

All supplied in 50 metre coils  
# To special order only  
All dimension in millimetres

\* Profile drawings appearing in this section are indicative only. some profiles may be restricted to specific customers, patents and or other limitations.  
The material displayed on this page may not be reprinted or otherwise reproduced without the express written permission of Boss Polymer Technologies.

BOSS POLYMER TECHNOLOGIES PTY LTD  
Melbourne Australia  
PH: (613) 9561 2777  
FAX: (613) 9560 8777  
www.bosspolymer.com.au  
E-MAIL: sales@bosspolymer.com.au

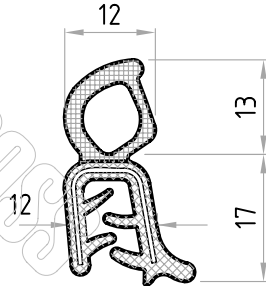

Part No. 042-0028

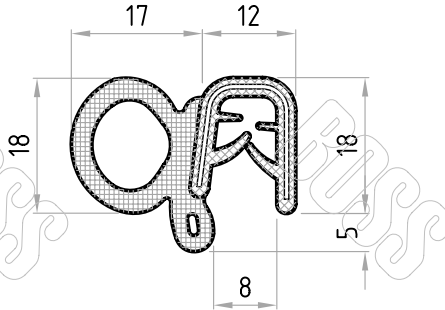

Part No. 042-0029

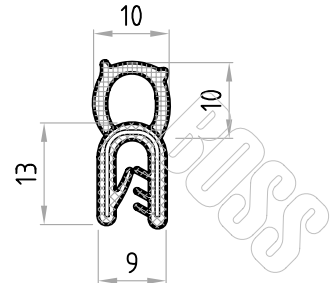

Part No. 042-0030 SCH\*

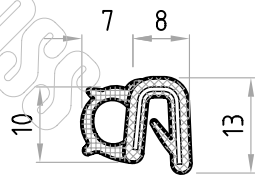

Part No. 042-0031 SCH\*

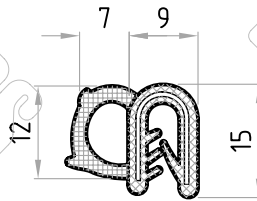

Part No. 042-0032 SCH\*

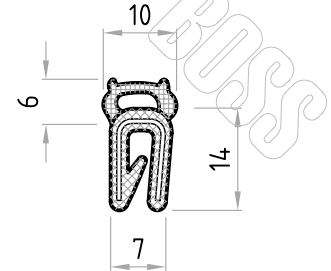

Part No. 042-0033 SCH\*

All supplied in 50 metre coils

\* Part nos. suffixed by the letter sch incorporate Schlegel type wire cage for maximum flexibility.

All dimension in millimetres

\* Profile drawings appearing in this section are indicative only. some profiles may be restricted to specific customers, patents and or other limitations.  
The material displayed on this page may not be reprinted or otherwise reproduced without the express written permission of Boss Polymer Technologies.

BOSS POLYMER TECHNOLOGIES PTY LTD  
Melbourne Australia  
PH: (613) 9561 2777  
FAX: (613) 9560 8777  
www.bosspolymer.com.au  
E-MAIL: sales@bosspolymer.com.au

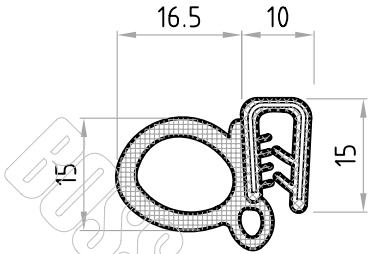

Part No. 042-0034 Black  
Equiv to BS283879

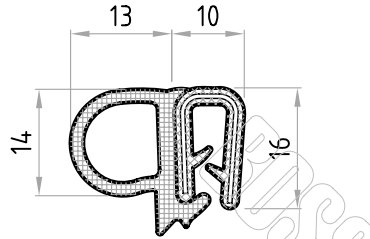

Part No. 042-0035N  
Black

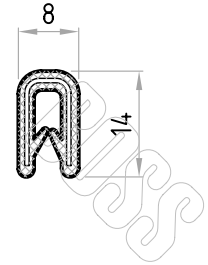

Part No. 042-0036B  
Black

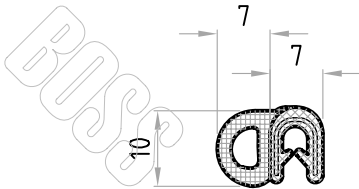

Part No. 042-0037 Black  
SUPPLIED IN 100 METRE COILS

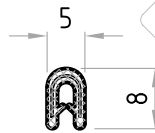

Part No. 042-0038 Black  
SUPPLIED IN 100 METRE COILS

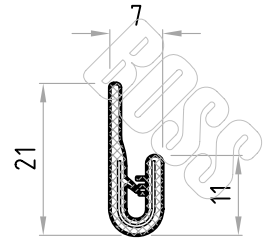

Part No. 042-0039#  
Black

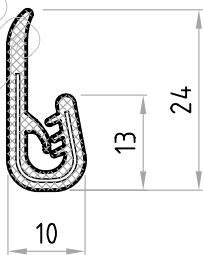

Part No. 042-0040# Black  
SUPPLIED IN 150 METRE COILS

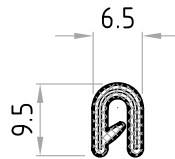

Part No. 042-0041 Black  
SUPPLIED IN 100 METRE COILS

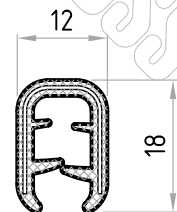

Part No. 042-0042 Camel  
Part No. 042-0043 Charcoal  
Part No. 042-0044 Blue/Grey  
SUPPLIED IN 100 METRE COILS

# To special order only  
unless ptherwise specified  
All supplied in 50 metre coil  
All dimensions in millimetres

\* Profile drawings appearing in this section are indicative only. some profiles may be restricted to specific customers, patents and or other limitations.  
The material displayed on this page may not be reprinted or otherwise reproduced without the express written permission of Boss Polymer Technologies.

BOSS POLYMER TECHNOLOGIES PTY LTD  
Melbourne Australia  
PH: (613) 9561 2777  
FAX: (613) 9560 8777  
www.bosspolymer.com.au  
E-MAIL: sales@bosspolymer.com.au

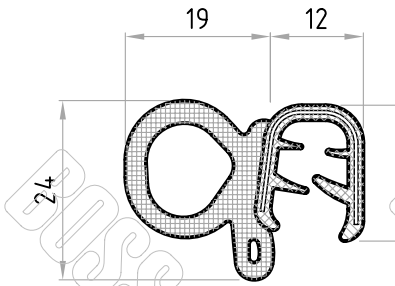

Part No. 042-0042/S Camel  
Part No. 042-0043/S Charcoal  
Part No. 042-0044/S Blue/Grey

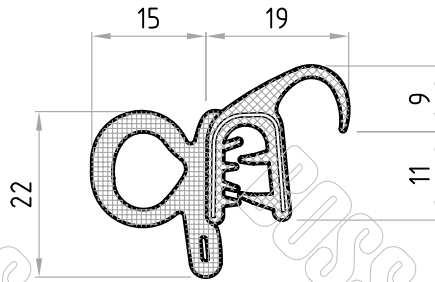

Part No. 042-0045G Grey

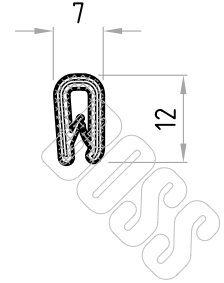

Part No. 042-0046

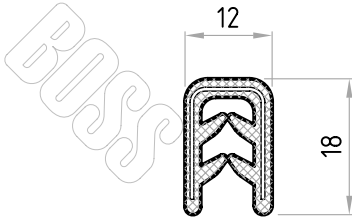

Part No. 042-0047 Black  
Equiv. to BS 224881  
Part No. 042-0048 Grey

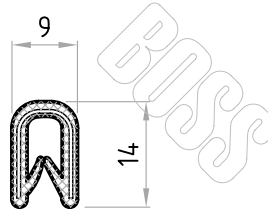

Part No. 042-0049

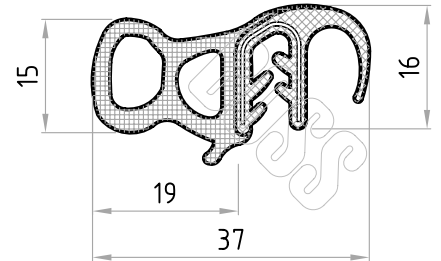

Part No. 042-0050 Grey

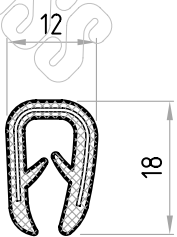

Part No. 042-0051  
Black

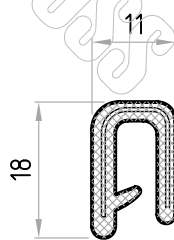

Part No. 042-0052  
Black

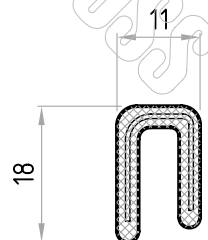

Part No. 042-0053  
Black

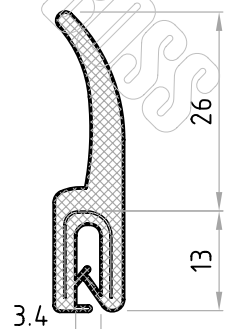

Part No. 042-0054  
GTS

# To special order only  
unless ptherwise specified  
All supplied in 50 metre coil  
All dimensions in millimetres

\* Profile drawings appearing in this section are indicative only.  
some profiles may be restricted to specific customers, patents  
and or other limitations.  
The material displayed on this page may not be reprinted or  
otherwise reproduced without the express written permission of  
Boss Polymer Technologies.

BOSS POLYMER TECHNOLOGIES PTY LTD  
Melbourne Australia  
PH: (613) 9561 2777  
FAX: (613) 9560 8777  
www.bosspolymer.com.au  
E-MAIL: sales@bosspolymer.com.au

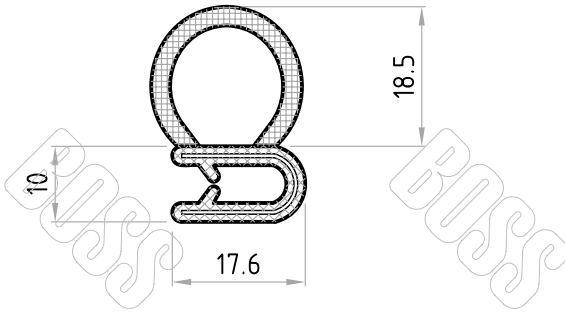

Part No. 042-0055

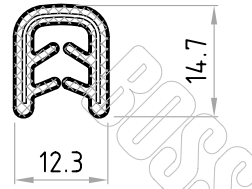

Part No. 042-0056

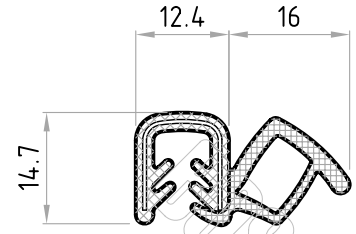

Part No. 042-0057

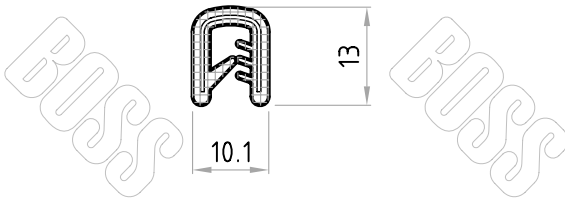

Part No. 042-0058

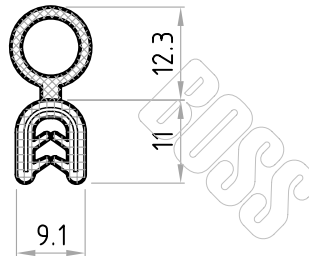

Part No. 042-0059

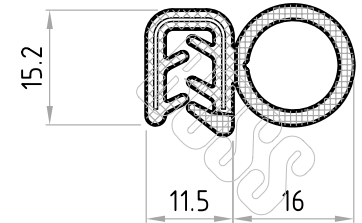

Part No. 042-0060

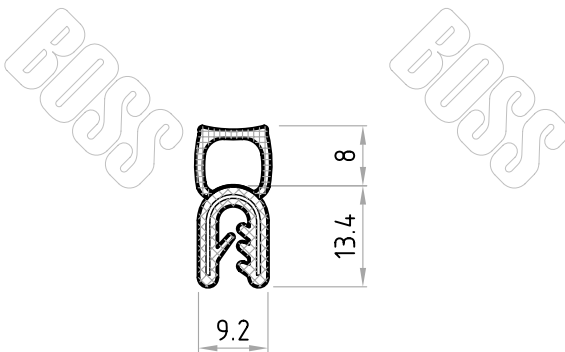

Part No. 042-0061

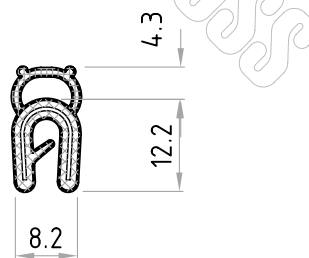

Part No. 042-0062

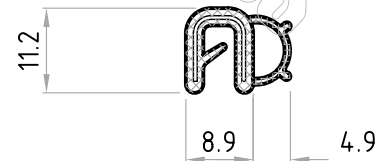

Part No. 042-0063

# To special order only  
unless otherwise specified  
All supplied in 50 metre coil  
All dimensions in millimetres

\* Profile drawings appearing in this section are indicative only. some profiles may be restricted to specific customers, patents and or other limitations.  
The material displayed on this page may not be reprinted or otherwise reproduced without the express written permission of Boss Polymer Technologies.

BOSS POLYMER TECHNOLOGIES PTY LTD  
Melbourne Australia  
PH: (613) 9561 2777  
FAX: (613) 9560 8777  
www.bosspolymer.com.au  
E-MAIL: sales@bosspolymer.com.au